

REDUCTEUR O&K N° 856178

Vue n° 1

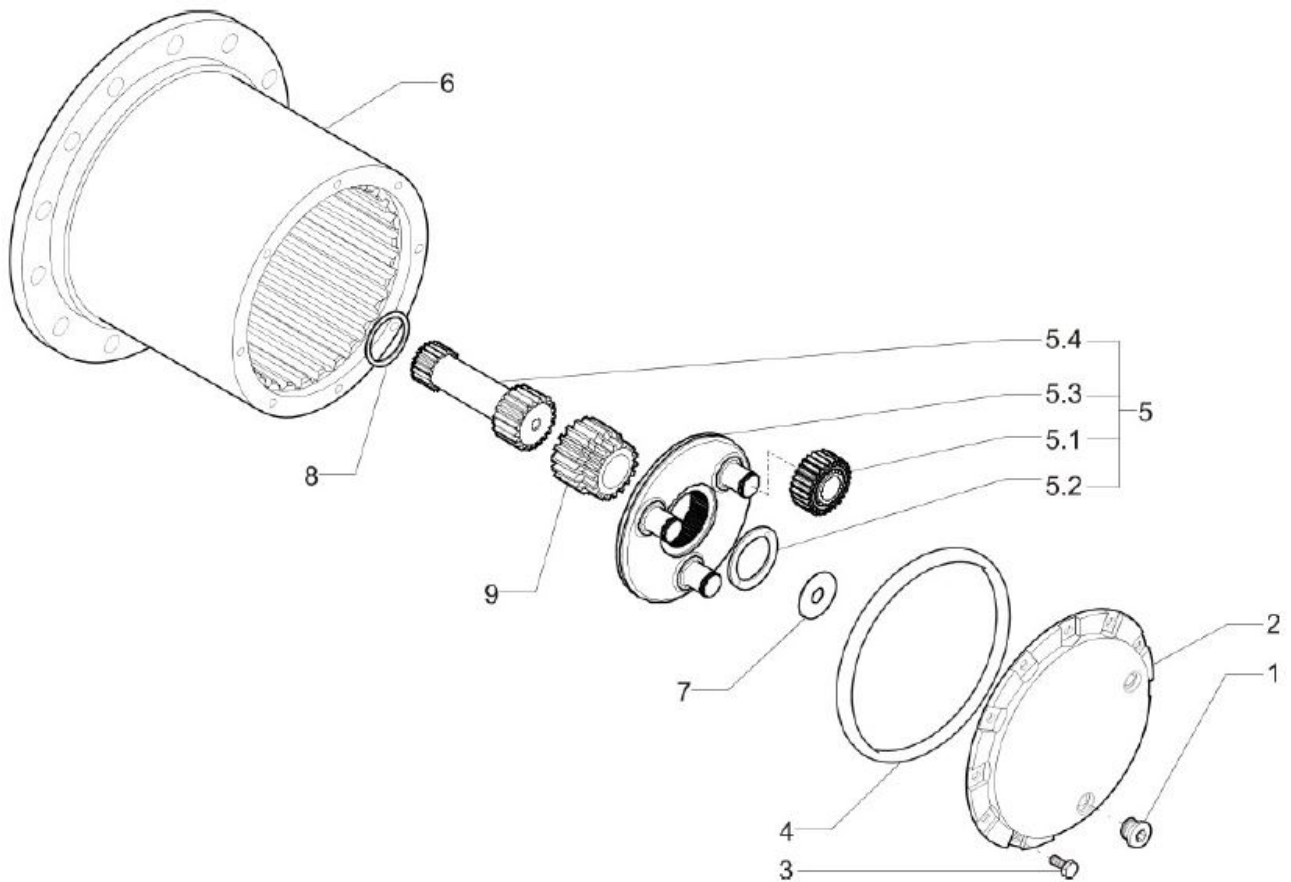

Vue n° 2

